

# Optimal Power Sharing Speed Compensation in On-road Wireless EV Charging Systems

Donovin D. Lewis<sup>1</sup>, Omer Onar<sup>2</sup>, Veda Prakash Galigekere<sup>2</sup>,  
Mostak Mohammad<sup>2</sup>, and Dan M. Ionel<sup>1</sup>

<sup>1</sup>SPARK Laboratory, ECE Department, University of Kentucky, Lexington, KY, USA

<sup>2</sup>Power Electronics and Electric Machinery Group, Oak Ridge National Laboratory, Knoxville, TN, USA  
donovin.lewis@uky.edu, onaroc@ornl.gov, galigekerevn@ornl.gov,  
mohammadm@ornl.gov, dan.ionel@uky.edu

**Abstract**—Dynamic wireless charging of electric vehicles (EV) is an emerging technology with the potential to address range anxiety and reduce the size of batteries or provide charge-sustaining operation. Charging demand for dynamic wireless charging systems (DWCS) varies greatly in response to location-specific traffic behaviors including the number and speed of vehicles. This paper highlights the potential reduction of load variation with speed compensation and simulates opportunities to maximize the number of cars charged concurrently through “power sharing” or altering power output to slower cars while maintaining a maximum delivered energy. An improved sub-minute model for synthetic traffic is proposed to effectively model DWCS load on high speed roadways and a power electronics model is created based on an existing prototype developed by ORNL to investigate the potential for power sharing. Reductions in the average speed of traffic can greatly increase instantaneous DWCS load by as much as 26%, complicating capacity sizing. Parametric studies with a LCC-S power electronics model shows feasible power reduction of more than 20%, while maintaining a maximum achievable efficiency greater than 90%. Speed compensation on a roadway with large speed variation can reduce average power expected by 21% and increase the maximum number of cars charged simultaneously by 30%. The application of power sharing may significantly reduce load variability due to speed, allow for increased car hosting capability, and guarantee a maximum energy delivered.

**Index Terms**—Electric vehicle (EV), wireless charging, wireless power transfer, sensitivity analysis, power control.

## I. INTRODUCTION

In recent years, widespread interest in electric vehicles (EV) has grown to improve long-term sustainability, increase energy efficiency, and combat rising fossil fuel prices. To alleviate range anxiety caused by limited infrastructure and long charging duration, dynamic wireless charging systems (DWCS), charging of EVs while they are driving over a roadway, has become an emerging topic in the transition from combustion-vehicles. Studies have found that electrification of a percentage of the primary roadways in the US with DWCS can cover almost all expected light duty vehicle drive cycles in charge-sustaining operation or allow for significant reductions in on-board vehicle battery size [2], [3].

DWCS uses electromagnetically coupled coil pairs, with an example prototype shown in Fig. 1, to transfer near constant power from grid-connected, ground-embedded transmitters connected as a track under a traffic lane to receivers embedded

in moving vehicles. Output power may be controlled by grid-side power electronics in response to vehicle’s positions on the track and systems-level controls depending on the speed and number of vehicles as discussed in Lewis et al. [4]. A diagram of the power conversion stages for wireless power transfer (WPT) can be found in Fig. 1 and summarized as the conversion of grid 60Hz AC to 79-90kHz AC between the transmitter and receiver with a final rectification stage to charge the EV battery. Synthetically generated data for DWCS traffic load prediction, similar to that used in Rong et al., combines stochastic modeling and measured data to aid in system planning and has predicted large spikes of multiple MWs (depending on the power level), and high power demand variability minute-to-minute [5], [6].

Dynamic wireless charging development and application benefits from the interdisciplinary integration of component-level power electronics with systems-level traffic-based load modeling. Previous studies pairing traffic modeling and energy transfer have indicated that the energy transferred to each car and impact on the grid can vary significantly on vehicle speed but have not analyzed the trade-offs of traffic speed variation on load or the maximum consumers during peak periods [6]–[8]. The impact of vehicle speed on efficiency of transferred energy was very recently studied in [9] with suggestions to limit speeds within an allowable band for enhanced charging performance. The modification of energy transferred to vehicles depending on speed was also explored in Wang et al., through output voltage or vehicle resistance alteration, to increase energy transferred, enabling charge-sustaining mode at higher speeds [10].

To the authors’ knowledge, the impact of slow downs and changes in aggregate traffic speed on total system power demand has yet to be explored in previous work. To fill this identified gap in the literature, this study focuses on the approximation of traffic speed-related load variation through an improved second-resolution traffic model for DWCS load approximation and introduces modified power electronic control to “share power” between a maximal number of cars with a wide range of speeds. Regulation of the energy charged per vehicle reduces the potential impact of speed-related power variability on power electronics and the interconnected power system and allows for increased car hosting capability.

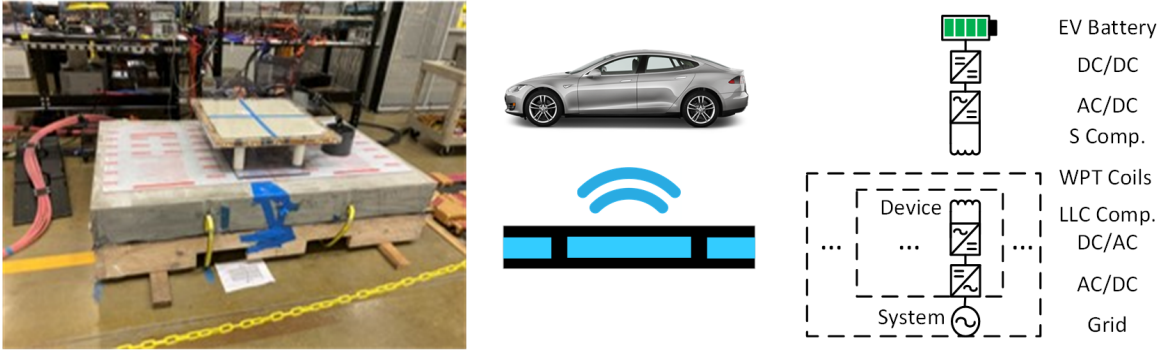

Fig. 1. A prototype transmitter and receiver coil pair for wireless charging testing and a diagram of an example wireless power transfer system for charging electric vehicles with power-systems level control and power electronics control to compensate for variability. Models employed in this study are based on previously published prototypes from ORNL experimentally validated at 85kHz, 120kW operation and simulated up to 200kW [1].

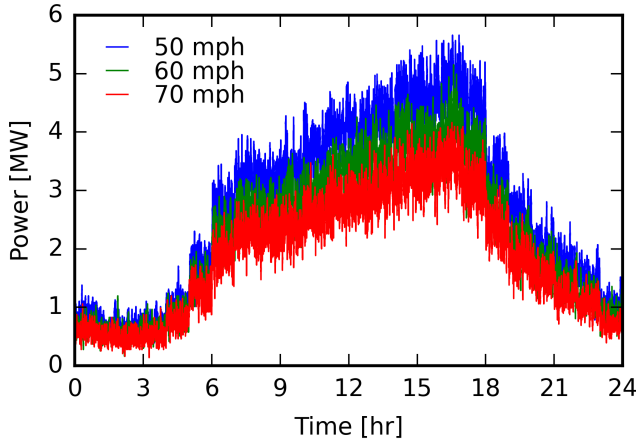

Fig. 2. Power demand curve without speed compensation using speed normal distribution sampling for example average speeds. As the average speed of cars is reduced, the maximum instantaneous power drastically increases by as much as 26%.

## II. POWER SHARING THROUGH OPTIMAL CONTROLS

DWCS power demand varies greatly depending on the speed of traffic. Energy transferred to vehicles in-motion over dynamic wireless power transfer track can be approximated by  $E(V) = P * \eta * \left( \frac{L_t * \Delta t}{S_v(V)} \right)$  where  $\eta$  is the efficiency,  $L_t$  the length of the track,  $\Delta t$  time step resolution, and  $S_v(V)$  the speed of the vehicle. Reductions in vehicle speed while maintaining maximum power level increases the energy transferred to single cars but reduces the maximum number of cars that can be charged simultaneously, limiting available power similar to reductions in system efficiency. The impact of reduced speed on the maximum number of concurrent cars can be approximated as a product of the maximum concurrent cars at the base speed and the ratio of the new lower speed and the base speed. Ensuring a maximal number of cars can be charged concurrently enables the opportunities for self-sustaining operation or reduction in on-board battery size.

Building upon previous studies of stochastically defined DWCS roadway modeling [4], an improved traffic model was

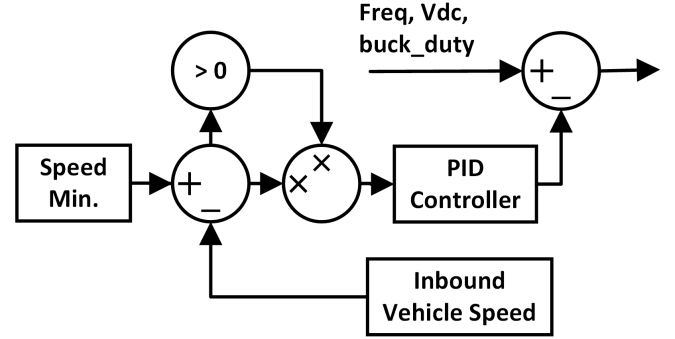

Fig. 3. Proposed control scheme to adjust power electronics parameters from the systems level, altering the real power output wirelessly transferred to the moving vehicle.

created for synthetic data generation, simulating car travel at a second resolution and establishing a speed compensation method like that shown in Fig. 3. Automated Traffic Recorder (ATR) data at I-75 near Bowling Green, Kentucky measured over the course of 3 years, 2017-2019, and annual average daily traffic (AADT) from the Kentucky Transportation Cabinet's Traffic Counts Map [11] was used to build the distribution for time of arrival for vehicles on the roadway. Speeds of vehicles entering the roadway are sampled from a normal distribution and held constant until they exit the road. Assuming 230kW input at 90% efficiency from [5] and [1], the average speed was varied between 50-70mph to generate 10 sets of synthetic data all averaged to approximate variation due to reduced speed. Resulting power demand curves in Fig. 2 showcase large variation in maximum and average power during the daily peak of travel between 6 and 18:00 hours with a 26% maximum power difference.

Roads with vehicles travelling at speeds greater than 60mph require traffic simulation at a sub-minutely timestep to accurately approximate maximum and maximum power demand. For example, if the mean speed of cars on the roadway is 70mph and the roadway is 1 mile long, then the average crossing is 51.43 seconds and minutely simulation would only

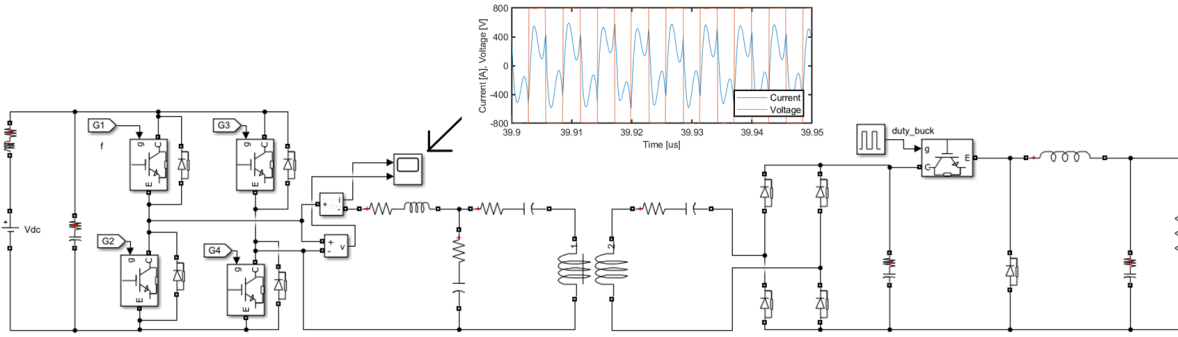

Fig. 4. MATLAB/Simulink model of LCC-S WPT power electronics simulated to study methods of power sharing with an example voltage and current output from the HF inverter (top waveforms).

see a peak when it appears on the track at the beginning of the minute. Similarly, minute-based vehicle arrival approximation leads to a peak of cars at the minute but does not capture the variability within that minute as cars continue down the track. As a result, minute-based traffic simulation overestimates maximum power expected due to vehicle arrival peaks and underestimates average power as it does not fully represent the duration of vehicle travel. Simulation at a second time step distributes when cars enter the roadway and ensures that the inflow of cars does not artificially peak as all vehicles arriving within a minute do not start at the same time.

Localized dynamic power electronics control like that proposed in Fig. 3 can alter system parameters depending on vehicle speed. By reducing power delivered to vehicles traveling slower than a pre-defined minimum speed, more vehicles can be charged simultaneously while guaranteeing a maximum energy transferred to individual vehicles. 100 sets of traffic load were synthetically generated using the improved traffic model with speed compensation for minimum speeds ranging from 55 to 75mph and a speed standard deviation of  $\pm 15$ mph. Simulation assumptions include that 100% of vehicles have WPT capability, coils are activated immediately as vehicles cross over the track, and all vehicles are assumed to be within their own coil section. Example load reduction with speed compensation is shown in Fig. 5 resulting in average and maximum power reductions up to 21% and 24% respectively depending on the defined minimum speed.

### III. MODIFIED POWER ELECTRONICS OPERATION

A 200kW, 85kHz WPT simulation was developed in MATLAB/Simulink, as shown in Fig. 4 to explore methods of reducing power transferred to cars below a pre-defined minimum speed to share between more customers while minimizing reductions to efficiency. The coupling coefficient was kept constant to estimate changes in maximum achievable efficiency assuming maximum alignment of the transmitter and receiver coils. The power electronics model contains the rectified DC input from the grid to the DC output to the battery pack, represented by a resistive load. A buck converter was integrated into the topology to manage output voltage maximum within acceptable limits for the EV battery (400V) and can be used to regulate power on the secondary-side.

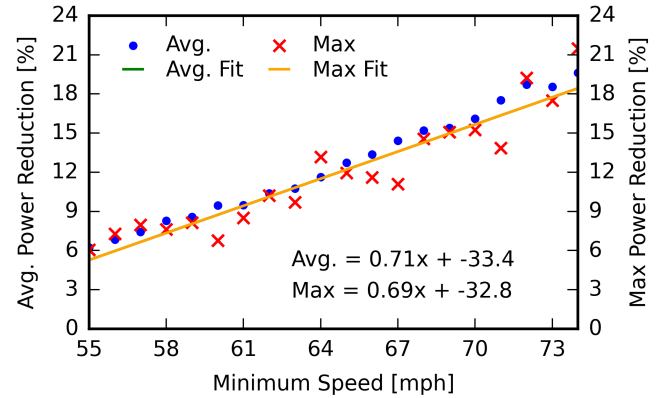

Fig. 5. Results of power compensation applied in a black-box model for dynamic wireless power transfer using real road data and applying speed compensation with 65mph and  $\pm 15$ mph speed deviation and multiple minimum speeds.

LCC-S compensation is used to minimize the size and complexity of onboard secondary compensation and reduce transmitter power in the absence of cars on the roadway [12]. Compensation circuit parameters are calculated based on the simplified process described in [13] with output power greatly controlled by the size of the primary inductance:

$$L_{1s} = M \frac{V_{in}}{V_{out}} \quad (1)$$

$$C_{1p} = \frac{1}{\omega^2 L_{1s}}, C_{1s} = \frac{1}{\omega^2 L_p - L_{1s}}, C_{2s} = \frac{1}{\omega^2 L_s}, \quad (2)$$

where,  $L_{1s}$  is the primary series inductor value;  $M = k\sqrt{L_p * L_s}$  the peak mutual inductance;  $V_{in}$  and  $V_{out}$  are the AC voltage input and DC voltage output respectively;  $C_{1p}$  is the parallel capacitor value for the primary;  $C_{1s}$  the primary series capacitor value;  $\omega$  the angular frequency;  $L_p$  the transmitter inductance;  $C_{2s}$  the secondary series capacitance; and  $L_s$  the secondary inductance. The gain applied to (1) can be used to vary output voltage and the resulting output power following  $P = V^2/R$  where  $R$  is the equivalent resistance representing the EV battery.

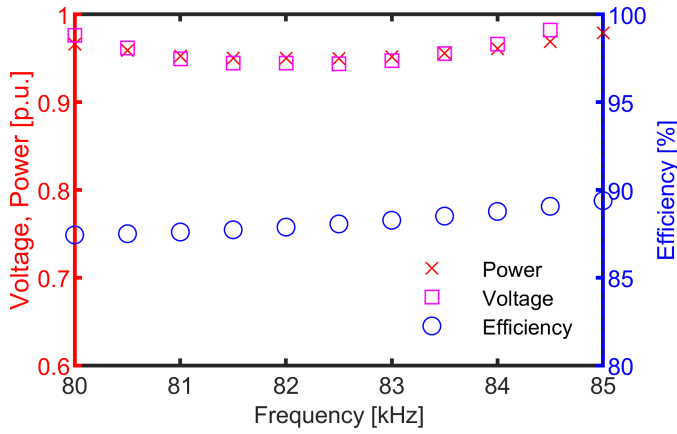

Fig. 6. Output voltage, power, and DC-DC efficiency from a parametric sweep of frequency between 80 and 85kHz. Modification of frequency does not significantly reduce the power delivered.

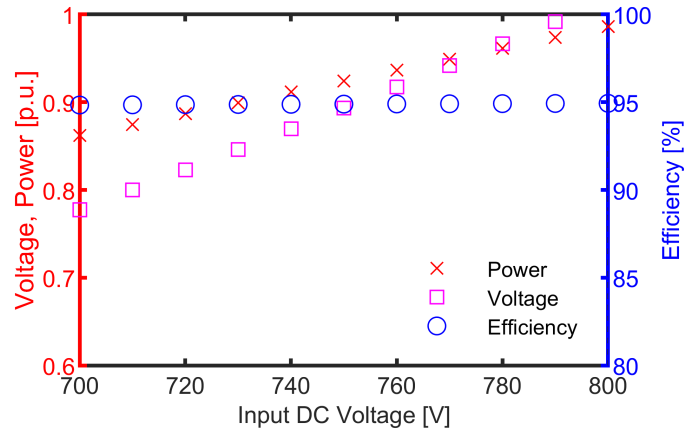

Fig. 7. Output voltage, power, and DC-DC efficiency from a parametric sweep of input DC voltage between 700 and 800V. Altering the DC input voltage offers the most power reduction with limited impact on efficiency.

Device-level parameters including on-state resistances and line impedances are directly used from previous experimentation with buck converter inductance and DC link capacitors sized for minimal voltage and current ripples. A maximum coupling coefficient of .15 is assumed with primary and secondary coil self-inductances from a previous 200kW, 85kHz simulation with a similar compensation scheme [12]. CAS325M12HM2 Silicon Carbide switches were used for minimal conduction and switching losses [1]. The resulting model has a DC-DC efficiency of 95% at 85kHz, 200kW steady-state operation with comparable performance to a similar system that has been experimentally validated to 91% efficiency at 120kW, 85kHz operation in [1].

Output voltage, power, and maximum achievable DC-DC efficiency were calculated with a parametric sweep of the primary-side switching frequency, input DC voltage, and secondary-side buck converter duty cycle as shown in Figs. 6, 7, and 8. Parameters were altered one by one in simulations ran with ranges from 80 to 85kHz; 700 to 800V; and 15 to 25% duty cycle respectively, while keeping the same compensation circuit parameters and targeting 800V input/400V output, 85kHz, 200kW operation.

#### IV. RESULTS AND DISCUSSION

Simulation results for speed compensation with a speed standard deviation of  $\pm 15$ mph and a range of minimum speeds from 55 to 75mph are shown in Fig. 5 and show a linear trend in the reduction of maximum and average power. As the minimum speed is increased, the reduction in average power and maximum power is increased as more cars are restricted in their power usage, while maintaining the same energy throughput. Methods of traffic modeling with speed compensation are generally applicable to other roadways assuming sufficient data availability.

Parametric sweeps of primary-side switching frequency, input DC voltage, and high frequency PWM duty cycle in Figs. 6, 7, and 8 highlight multiple opportunities for power sharing to compensate for speed. Most notably, altering DC

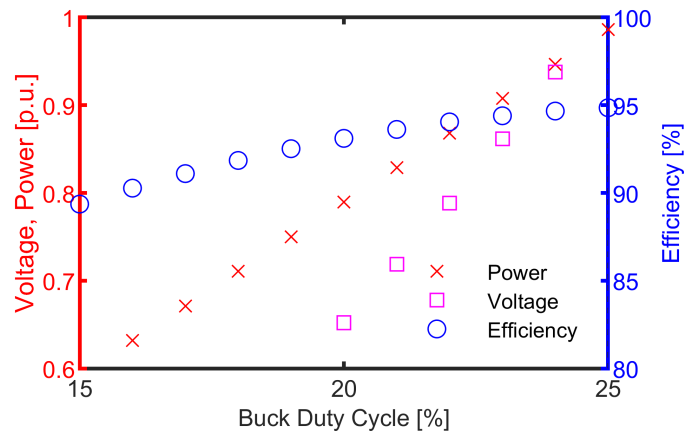

Fig. 8. Output voltage, power, and DC-DC efficiency from a parametric sweep of buck converter duty cycle between 15 and 25%. Buck converter modification can significantly reduce power but has a large impact on voltage.

input voltage can reduce output power by more than 10% and has very little impact on efficiency. Modifying the frequency of the transmitter does not have a large effect on delivered power but is essential for maintaining system efficiency due to the resonant tuning network. The secondary-side buck converter duty cycle can be altered to maintain the target voltage range alongside primary-side parameters to reduce input power.

Using the latest silicon carbide wide band gap device technology, power losses are expected to be maintained very low throughout the entire operation range with frequency and load. Simulations indicate a potential power reduction by more than 40% while maintaining efficiency greater than 90%. Assuming a maximum reduced speed of 55mph or a 21% drop in speed relative to the speed limit, the modification of DC input voltage alone could satisfy the proposed "power sharing" power electronics operation without reducing maximum achievable efficiency below 90%.

The integration of power electronics and traffic modeling enables enhanced planning and operational control to accommodate the largest number of consumers possible. Advanced

unified monitoring of the vehicle status, communication with centralized DWCS control, and the capability to alter power electronic controls accordingly is necessary to modify transmitted power as proposed. Rather than modification of the speed limit, localized dynamic control of the system depending on vehicle speed can mitigate system load, while managing energy transfer without system-wide or component-level changes. As a result, the standard deviation of energy transferred to each vehicle is reduced by half and the energy transfer becomes much more predictable, increasing the capability to plan for charge-sustaining operation.

## V. CONCLUSION

A new power electronics control method has been proposed for dynamic wireless power transfer power sharing to maximize the number of cars charged when traffic slows down. Improved second-based synthetic load generation was used to capture quick variability in traffic-related load and highlight how large variance in speeds can significantly increase maximum and average power demand. Systems-level results found that compensating for large speed deviations ( $\pm 15$ mph) significantly reduces maximum instantaneous power demand by 24% and the average power by 21%. MATLAB/Simulink power electronic simulations of a LCC-S WPT system derived from an existing 200kW, 85kHz prototype found that power transferred can be reduced sufficiently, by more than 10%, without reducing the maximum achievable efficiency below 90%. Power sharing or reducing power transmitted to cars reduces the variability of DWCS load and ensures consumers receive the same maximum charging energy.

## ACKNOWLEDGMENT

This work was supported by the National Science Foundation (NSF) Graduate Research Fellowship under Grant No. 1839289. Any findings and conclusions expressed herein are those of the authors and do not necessarily reflect the views of the NSF. The support of the University of Kentucky, the L. Stanley Pigman Chair in Power endowment is also gratefully acknowledged.

## REFERENCES

- [1] L. Xue, V. Galigekere, G.-j. Su, R. Zeng, M. Mohammad, E. Gурpinar, S. Chowdhury, and O. Onar, "Design and analysis of a 200 kw dynamic wireless charging system for electric vehicles," in *2022 IEEE Applied Power Electronics Conference and Exposition (APEC)*, 2022, pp. 1096–1103.
- [2] A. Foote, B. Ozpineci, M. Chinthavali, and J.-M. Li, "Sizing dynamic wireless charging for light-duty electric vehicles in roadway applications," in *2016 IEEE PELS Workshop on Emerging Technologies: Wireless Power Transfer (WoW)*, 2016, pp. 224–230.
- [3] B. J. Limb, T. H. Bradley, B. Crabb, R. Zane, C. McGinty, and J. C. Quinn, "Economic and environmental feasibility, architecture optimization, and grid impact of dynamic charging of electric vehicles using wireless power transfer," in *6th Hybrid and Electric Vehicles Conference (HEVC 2016)*, 2016, pp. 1–6.
- [4] D. D. Lewis, H. Gong, G. Erhardt, R. Zeng, O. Onar, V. P. Galigekere, B. Ozpineci, and D. M. Ionel, "Sizing considerations for ev dynamic wireless charging systems with integrated energy storage," in *2022 IEEE Transportation Electrification Conference & Expo (ITEC)*, 2022, pp. 611–616.
- [5] R. Zeng, V. P. Galigekere, O. C. Onar, and B. Ozpineci, "Grid integration and impact analysis of high-power dynamic wireless charging system in distribution network," *IEEE Access*, vol. 9, pp. 6746–6755, 2021.
- [6] C. A. García-Vázquez, F. Llorens-Iborra, L. M. Fernández-Ramírez, H. Sánchez-Sainz, and F. Jurado, "Evaluating dynamic wireless charging of electric vehicles moving along a stretch of highway," in *2022 International Symposium on Power Electronics, Electrical Drives, Automation and Motion (SPEEDAM)*, 2016, pp. 61–66.
- [7] S. Debnath, A. Foote, O. C. Onar, and M. Chinthavali, "Grid impact studies from dynamic wireless charging in smart automated highways," in *2018 IEEE Transportation Electrification Conference and Expo (ITEC)*, 2018, pp. 950–955.
- [8] A. O. el Meligy, E. A. Elghanam, M. S. Hassan, and A. H. Osman, "Deployment optimization of dynamic wireless chargers for electric vehicles," in *2021 IEEE Transportation Electrification Conference Expo (ITEC)*, 2021, pp. 113–118.
- [9] K. Kumar, K. V. V. S. R. Chowdary, B. Nayak, and V. Mali, "Performance evaluation of dynamic wireless charging system with the speed of electric vehicles," in *2022 IEEE 19th India Council International Conference (INDICON)*, 2022, pp. 1–4.
- [10] Y. Wang, R. Yuan, Z. Jiang, S. Zhao, W. Zhao, and X. Huang, "Research on dynamic wireless ev charging power control method based on parameter adjustment according to driving speed," in *2019 IEEE 2nd International Conference on Electronics Technology (ICET)*, 2019, pp. 305–309.
- [11] "Traffic Counts," publisher: Kentucky Transportation Cabinet. [Online]. Available: <https://maps.kytc.ky.gov/trafficcounts/>
- [12] U. D. Kavimandan, V. P. Galigekere, O. Onar, M. Mohammad, B. Ozpineci, and S. M. Mahajan, "The sensitivity analysis of coil misalignment for a 200-kw dynamic wireless power transfer system with an lcc-s and lcc-p compensation," in *2021 IEEE Transportation Electrification Conference & Expo (ITEC)*, 2021, pp. 1–8.
- [13] C.-H. Jo and D.-H. Kim, "Novel compensation parameter design methodology and maximum efficiency tracking control strategy for inductive power transfer system," *IEEE Access*, vol. 10, pp. 56 133–56 144, 2022.